

## NivuFlow 750

High accurate flow measurement for slightly polluted and dirty media in part filled and full pipes, channels and more



## Our proven transmitter family systematically developed further

Flow measurement systems by NIVUS stand for innovation, reliability and highest accuracy.

NivuFlow 750 is a fixed transmitter for continuous flow measurement, flow control as well as for storage of measurement values recorded in slight to heavily polluted media featuring various consistencies.

It is designed for use in open channels, closed and part filled pipes with various shapes and dimensions. The transmitter can handle up to 3 measurement spots and up to 9 flow sensors.



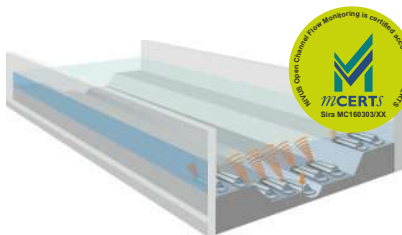
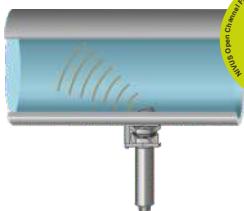
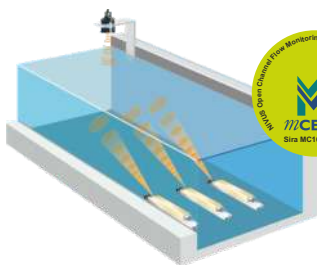
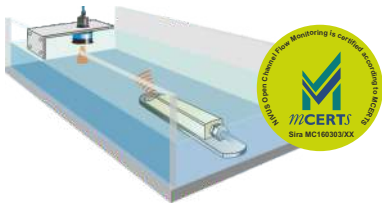

## Flow measurement systems at the highest technical level

- Very high measurement accuracy
- Suitable even for very difficult applications
- Up to 3 measurement spots and up to 9 flow sensors (M9 version)
- Real-time measurement of real flow velocity profiles
- Intuitive, modern operating concept for quick and easy initial start-up
- Integrated numeric flow models
- Measurement in channels, part filled and full pipes as well as flumes
- Weatherproof version for outdoor use
- Ex approval Zone 1
- High-resolution graphic daylight display
- Extensive diagnostic functions for reliable initial start-up and quick maintenance
- Compact construction for narrow switching cabinets
- Quick wiring thanks to easily accessible connection points
- Universal, standardised interfaces for easy integration
- Online connection/data transmission and remote maintenance via Internet
- MCERTS certified



## Typical Applications

WWTPs, channel networks, discharge constructions, industrial wastewater networks, measurement places for billing, intakes, drainage lines, return sludge lines, recirculation lines and many more



## The right sensor for each application

The complete flow measurement system consists of the NivuFlow 750 transmitter and the appropriate sensors.

For flow velocity measurement starting at flow levels as low as 3 cm up to several meters in pipes, flumes and channels of various shapes and dimensions there is a wide selection of sensors available: flow velocity sensors with and without integrated flow level measurement as well as air-ultrasonic flow level sensors.

### Your benefits

- Absolutely zero point stable and drift-free sensors
- Low installation expenses through perfectly matched mounting accessories
- Installation under process conditions
- Various sensor constructions guarantee the best solution for each application
- Digital signal transmission for error-free connections over long distances
- Ex approval Zone 1
- No shut down to flow with pipe sensors



*Air-ultrasonic sensor for level measurement, installed in flume crown*

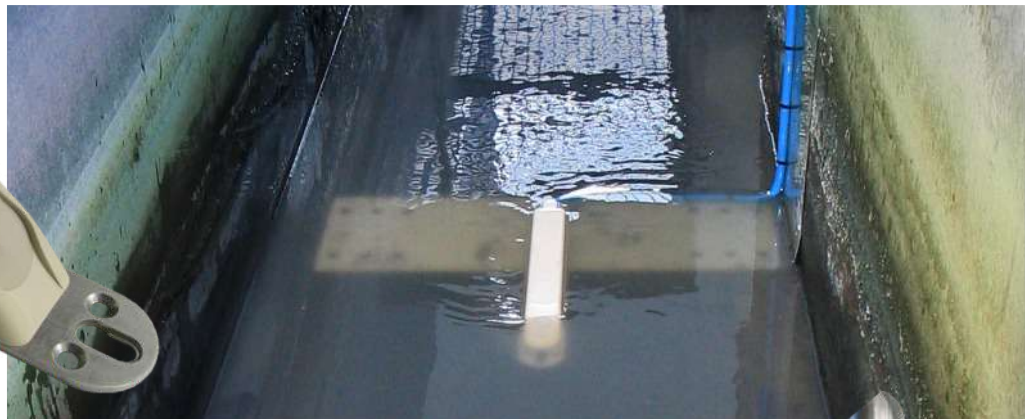

*Flow velocity sensors for installation on channel bottom or channel walls*



*Flow velocity sensors for installation in pipes and in the NIVUS Pipe Profiler*

### Mini Sensor family for small channels

Flow velocity sensor CSM

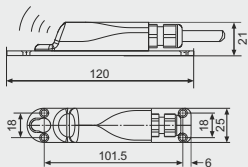

Flow velocity sensor CSM-D

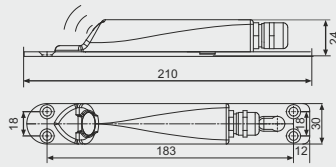

Flow velocity sensor CSM-V100RX

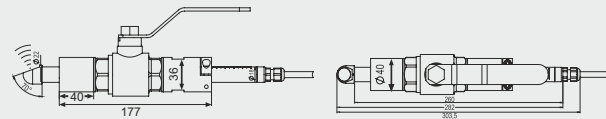

Level sensor, Type DSM



Electronic Box, Type EBM

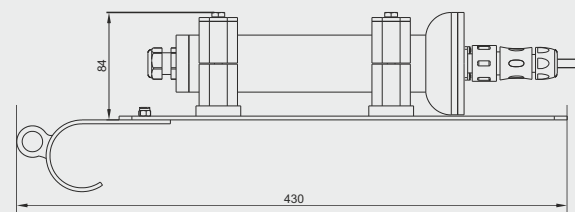

Dimensions in mm

#### Flow velocity sensor Type CSM, CSM-D and CSM-V100R

Measurement principle	cross correlation detecting the real flow profile
Minimum fill level	CSM: 3 cm, CSM-D: 5.5 cm
Protection	Ip68
Ex-Approval (optional)	II 2 G Ex ib IIB T4 Gb
Measurement range	-100 cm/s to +600 cm/s
Operating temp.	-40 °C to +80 °C in Ex Zone 1
Operating pressure	CSM: max. 4 bar, CSM-D: max. 1 bar CSM-V100R: max. 16 bar
Number of scan layers	max. 16
Meas. uncertainty (per scan layer)	< 1 % of measurement value ( $v > 1$ m/s) < 0.5 % of measurement value +5 mm/s ( $v < 1$ m/s)
Zero point drift	absolutely stable zero point

#### CSM-D: level measurement - pressure

Measurement range	0 to 500 cm
Zero point drift	max. 0.75% of final value
Meas. uncertainty	< 0.5 % of final value

#### Level sensor, Type DSM

Measurement principle	transit time using air-ultrasound
Protection	Ip68
Ex-approval (optional)	II 2 G Ex ib IIB T4 Gb
Measurement range	0 to 200 cm
Meas. uncertainty	< ±5 mm
Dead zone	(starting at mounting plate) 4 cm

#### Electronic Box, Type EBM for connection to NIVUS transmitters

Protection	Ip68
------------	------

### Sensors POA/CS2 for medium and large channels

Water-Ultrasonic Sensors, Type POA

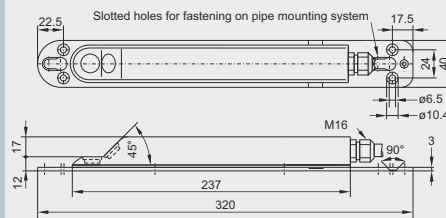

Vector Profiler, Type CS2

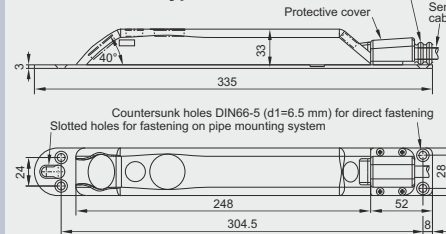

Air-Ultrasonic Level Sensor, Type OCL

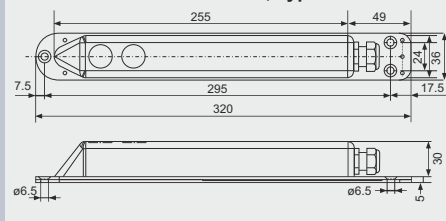

Dimensions in mm

Pipe Sensors Type POA

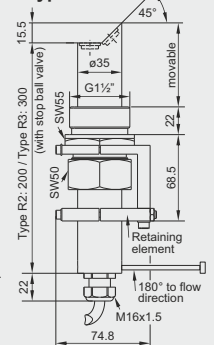

Type CS2

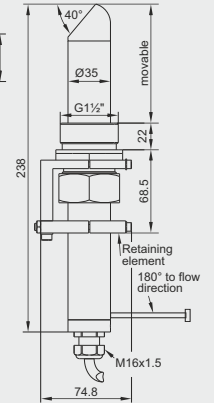

Ex-approval (optional)	II 2 G Ex ib IIB T4 Gb
Measurement principle	<ul style="list-style-type: none"> <li>cross correlation with digital pattern detection for flow velocity measurement</li> <li>ultrasonic transit time for level measurement</li> <li>piezoresistive pressure meas. for level measurement</li> </ul>
Meas. range (v)	-100 cm/s to +600 cm/s
Meas. range (h)	pressure 500 cm ultrasound internal up to 200 cm
Protection	Ip68
Ex Approval (optional)	II 2 G Ex ib IIB T4 (ATEX), Ex ib IIB T4 Gb (IECEX)
Operating temp.	-20°C to +50°C (-20°C to +40°C in Ex Zone 1)
Storing temperature	-30°C to +70°C
Meas. uncertainty	deviation < 1 % ( $v > 1$ m/s), < 0.5 % + 5 mm/s ( $v < 1$ m/s)
Operating pressure	max. 4 bar (combi sensor w. pressure cell max. 1 bar)
Cable length	up to 100 m, other lengths on request
Sensor types	<b>POA or CS2</b> (for levels of several meters): flow velocity using cross correlation or flow velocity and level, temperature measurement level measurement using water-ultrasound (optional) level measurement using pressure (optional)
Constructions	<b>OCL</b> : level measurement using ultrasound wedge sensor for installation on channel bottom or sidewall pipe sensor for installation in pipes

You can find the complete specifications in the instruction manual or on [www.nivus.com](http://www.nivus.com)

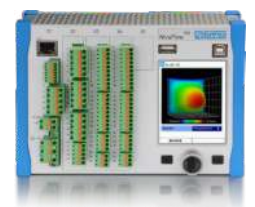

## Nivu Flow 750 - Universal transmitter

The intuitive one-hand operation and the bright high-resolution colour display allow quick, easy and cost-efficient commissioning on site. Additional input devices or software are not required.

The latest integrated numeric discharge models enable more accurate, more stable and more reliable determination of flow rates even under very difficult measurement conditions. The 3D flow profile is calculated in real time and is reproducibly and verifiably indicated on the transmitter display.

Factors influencing the calculation results such as channel shapes, discharge behaviour and wall roughness are considered during flow calculation.

In addition to the compact DIN rail version there is a weatherproof field unit available featuring appropriate connection space for outdoor installation



Screen display menu

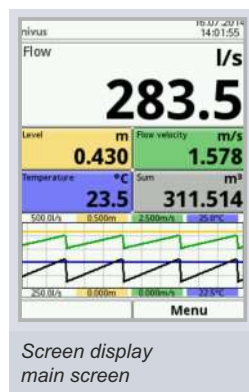

Screen display main screen

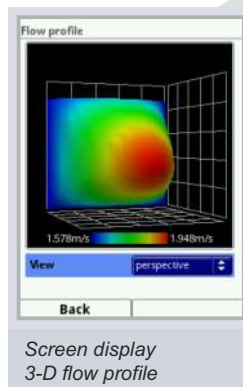

Screen display 3-D flow profile

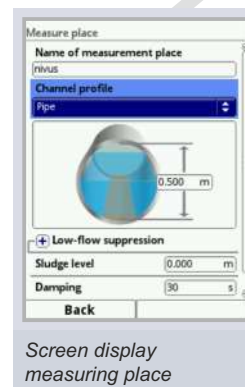

Screen display measuring place

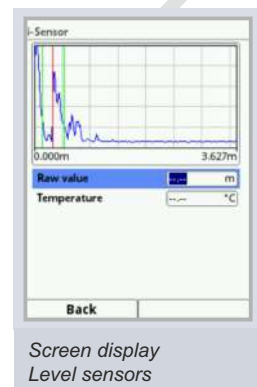

Screen display Level sensors



### Technical Information NivuFlow 750

#### DIN rail enclosure for easy installation in switching cabinet

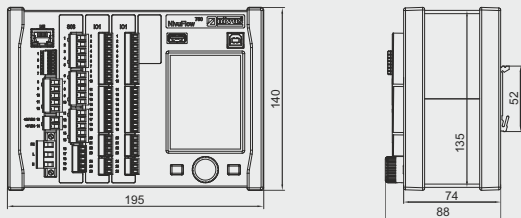

Dimensions in mm

#### Field enclosure

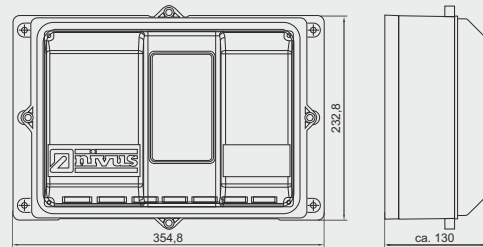

<b>Power supply</b>	85 to 240 V AC, +10 % / -15 %, 47 to 63 Hz or 9-36 V DC
<b>Power consumption</b>	typical 14 VA
<b>Enclosure</b>	Aluminium, plastic (installation in switching cabinet), plastic (field enclosure)
<b>Protection</b>	IP 20 (installation in switching cabinet), IP 68 (field enclosure)
<b>Operating temperature</b>	-20°C to +70°C
<b>Storage temperature</b>	-30°C to +75°C
<b>Max. humidity</b>	80%, non-condensing
<b>Display</b>	240 x 360 pixel, 65536 colours
<b>Operation</b>	rotary pushbutton, 2 function keys, menus in German, English, French, Swedish and other languages
<b>Connection</b>	plug with cage clamp terminals
<b>Inputs</b>	up to 7 x 4 - 20 mA, up to 4 x RS 485 for connection of up to 9 flow velocity sensors (via multiplexer)
<b>Outputs</b>	up to 4 x 0/4 - 20 mA, up to 5 x relays (SPDT)
<b>Controller</b>	3-step controller, quick close control, adjustable valve position in case of error
<b>Data memory</b>	1.0 GB internal memory, readout on faceplate via USB stick
<b>Communication</b>	Modbus, HART

You can find the complete specifications in the instruction manual or on [www.nivus.com](http://www.nivus.com)

*NivuFlow is available as unit for installation in control cabinet or with a robust field enclosure*



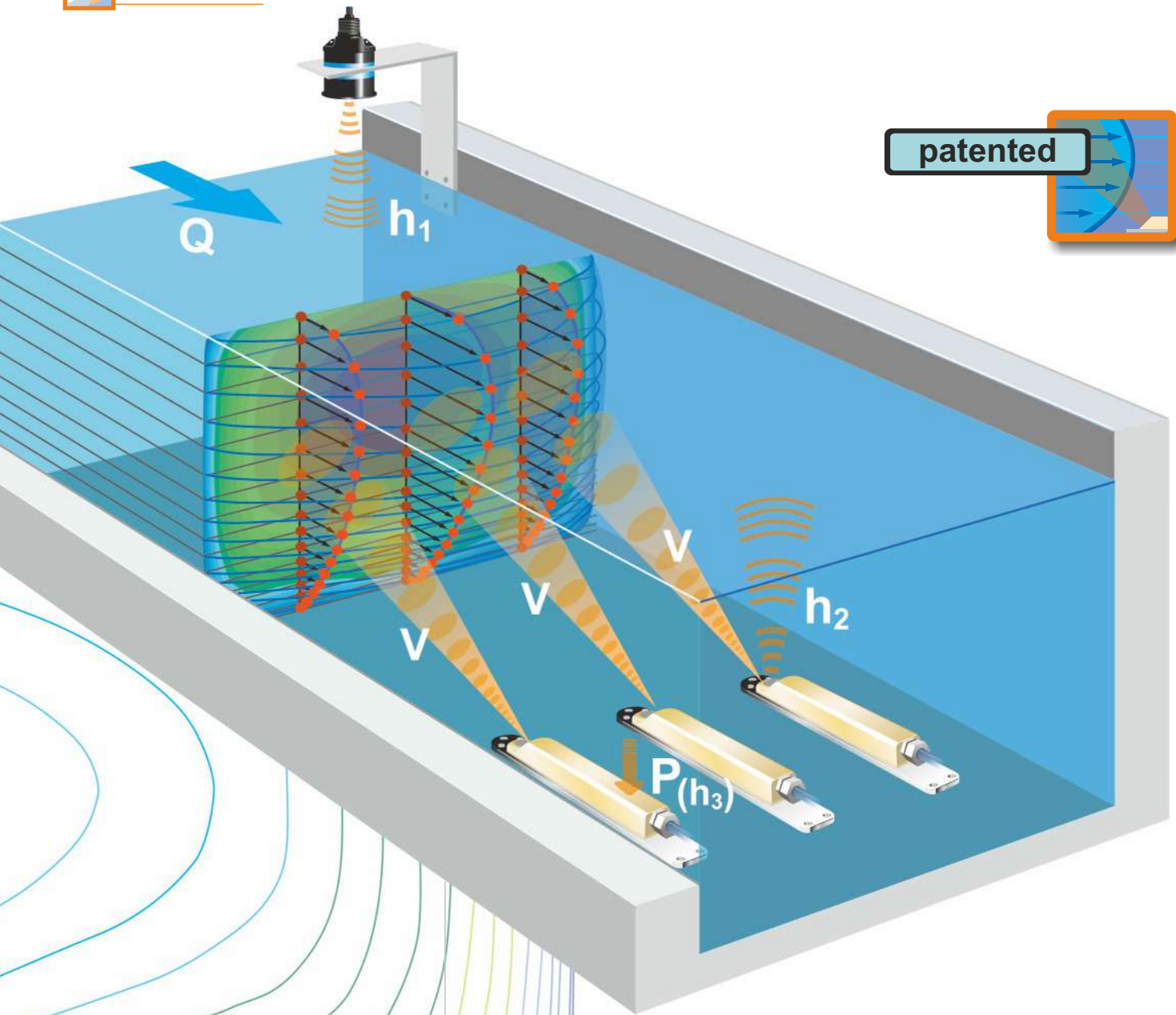

## How the NivuFlow 750 measures

Flow cannot be measured directly. Multiple factors are required to detect the flow Q: average flow velocity and the flow cross section which leads to the general formula:

$$Q = v_{(average)} \cdot A$$

The flow cross section A is investigated by continuously measuring the filling level considering the channel shape.

The flow velocity is detected by using the particles' velocity. Most media contain a certain load of dirt particles or gas bubbles which move in the same velocity as the liquid itself.



The flow measurement principle as video under: [www.nivus.com](http://www.nivus.com)



## Level measurement (h)

Accurate flow measurements require precise and reliable level detection under all hydraulic conditions. The development of a level measurement system with multiple redundancy is a result of our many years of experience. Combining hydrostatic measurement, water-ultrasound and air-ultrasound provides solutions for all measurement tasks.

External 4- 20 mA level sensors such as "i-Series" sensors or NivuBar Plus can be connected additionally.



## Flow velocity measurement (v) using cross correlation

The measurement method used for flow velocity determination is based on the principle of ultrasonic reflection. One of the most modern and most efficient measurement methods for flow velocity detection is the NIVUS cross correlation method.

Existing reflectors within the medium (particles, minerals or gas bubbles) are scanned using an ultrasonic impulse with a defined angle.

The resulting echoes are saved subsequently as images or echo patterns.

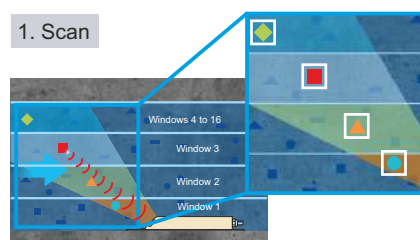

A few milliseconds later a second scan follows. The resulting echo patterns are saved as well.

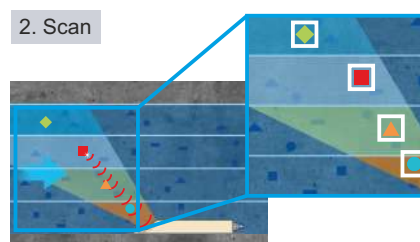

By correlating/comparing the saved signals, the positions of unambiguously identifiable reflectors can be identified. The reflectors can be identified at varying positions within the images since they have moved with the medium.



Overlay of image patterns

Considering the beam angle it is possible to directly compute the particle velocity and hence the medium flow velocity from the temporal shift of the reflectors.

This allows to obtain highly accurate readings without the need to perform additional calibration measurements.

Gates			
	Position	v average	v raw
1	0.065 m	0.392 m/s	0.423 m/s
2	0.074	0.403	0.421
3	0.080	0.399	0.379
4	0.088	0.410	0.393
5	0.096	0.436	0.441
6	0.106	0.481	0.507
7	0.117	0.499	0.490
8	0.129	0.522	0.504
9	0.144	0.532	0.512
10	0.160	0.542	0.522
11	0.179	0.560	0.526
12	0.201	0.546	0.512
13	0.226	0.555	0.510
14	0.257	0.547	0.502
15	0.292	0.540	0.500
16	0.333	0.531	0.503

Back

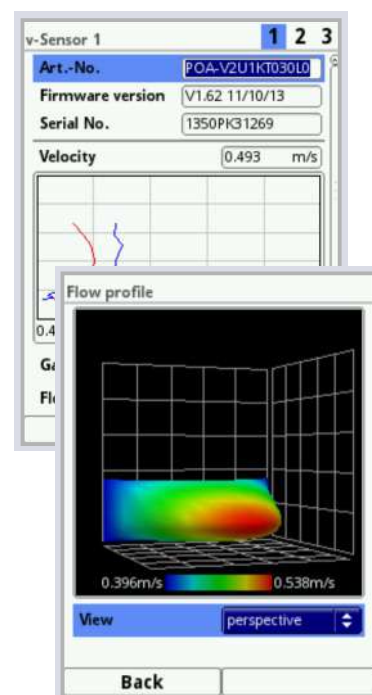

The NivuFlow 750 uses up to 9 x 16 gates for flow measurement. A flow profile can be directly indicated on the display.

### Your benefits

- Highest measurement accuracy
- Stable readings
- No calibration required
- Determination and indication of flow profiles



### On site from anywhere

- Integrated data logger for high data security
- Saved data can be recalled at any time
- Online operation and online setting of parameters (remote control)
- Quick and comprehensive remote diagnostics of entire measurement sites

## Latest Technologies

Based on the latest hydraulic models, the NIVUS-COSP system computes a dense measurement network covering the entire flow cross section from the individual measurement spots.

The NivuFlow 750 provides options for remote maintenance, remote diagnostics and the flexible integration into process conducting systems and telecontrol networks.

- Scientifically tested, channel-specific mathematical real-time flow models
- Calculation of flow velocity distributions in proximity to walls and horizontal velocity profiles
- Velocity integration covering the entire cross section
- Ideal to investigate average flow velocities in flumes with hydraulic disturbances

### EX Separation Module iXT / Multiplexer MPX

The Ex separation module iXT is a Multiplexer used for sensor connection in Ex zone 1.

The Multiplexer Type MPX allows the electronic combination of up to 3 flow velocity sensors and 3 level sensors on site.

#### Technical Information

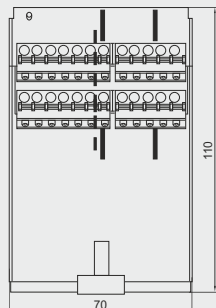
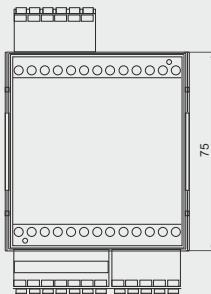

Dimensions in mm

<b>Power supply</b>	12 V DC, max. power consumption 9 W (typ. 7 W), supplied by transmitter
<b>Protection</b>	IP20
<b>Ex approval iXT</b>	ATEX and IECEx, ATEX: TÜV14ATEX142076, IECEx: TUN14.0014
<b>Inputs</b>	1 (optional 2) x analog 4-20 mA loop-powered sensor connection Ex ib Gb IIB, one of them HART compatible 2 (optional 4) x sensor connection Ex ib Gb IIB with RS485 interface
<b>Outputs</b>	RS 485 to transmitter

You can find the complete specifications in the instruction manual or on [www.nivus.com](http://www.nivus.com)

## Perfect solutions even under difficult conditions

### Your benefits

- Accurate and reliable measurement results
- Perfectly dimensioned measurement systems
- Saves costs thanks to quick and easy installation and commissioning procedures
- Low personnel expenses through integrated systems
- One competent contact person for all components

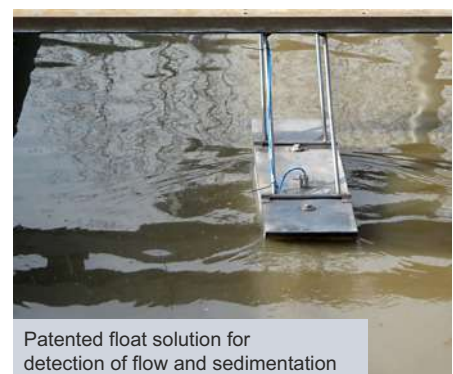
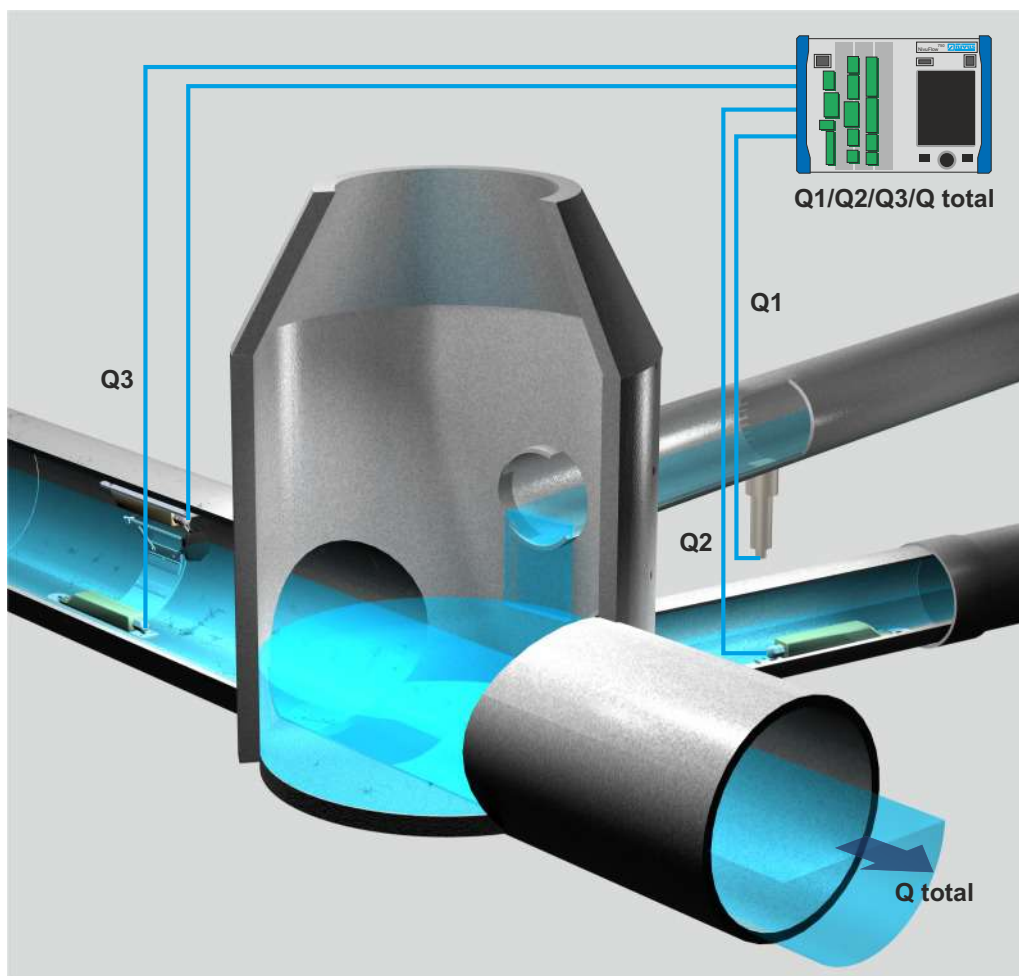

**NIVUS GmbH**

Im Taele 2  
75031 Eppingen, Germany  
Phone: +49 (0)7262 9191-0  
Fax: +49 (0)7262 9191-999  
info@nivus.com  
www.nivus.com

**NIVUS AG**

Burgstrasse 28  
8750 Glarus, Switzerland  
Phone: +41 (0)55 6452066  
Fax: +41 (0)55 6452014  
swiss@nivus.com  
www.nivus.com

**NIVUS Austria**

Mühlbergstraße 33B  
3382 Loosdorf, Austria  
Phone: +43 (0)2754 567 63 21  
Fax: +43 (0)2754 567 63 20  
austria@nivus.com  
www.nivus.com

**NIVUS Sp. z o.o.**

ul. Hutnicza 3 / B-18  
81-212 Gdynia, Poland  
Phone: +48 (0)58 7602015  
Fax: +48 (0)58 7602014  
biuro@nivus.pl  
www.nivus.pl

**NIVUS France**

17 Rue du Stade  
67870 Bischoffsheim, France  
Phone: +33 (0)388999284  
info@nivus.fr  
www.nivus.fr

**NIVUS Ltd.**

Head office UK:  
Wedgewood Rugby Road  
Weston under Wetherley  
Royal Leamington Spa  
CV33 9BW, Warwickshire, UK  
Phone: +44(0)1926632470  
info-uk@nivus.com  
www.nivus.com

**NIVUS Middle East (FZE)**

Building Q 1-1, ap. 055  
P.O. Box: 9217  
Sharjah Airport International  
Free Zone  
Phone: +971 6 55 78 224  
Fax: +971 6 55 78 225  
middle-east@nivus.com  
www.nivus.com

**NIVUS Korea Co. Ltd.**

#2502, M Dong, Technopark IT Center  
32 Song-do-gwa-hak-ro, Yeon-su-gu,  
INCHEON, Korea 21984  
Phone: +82 32 209 8588  
Fax: +82 32 209 8590  
korea@nivus.com  
www.nivus.com

**NIVUS Vietnam**

21 Pho Duc Chinh, Ba Dinh,  
Hanoi, Vietnam  
Phone: +84 12 0446 7724  
vietnam@nivus.com  
www.nivus.com